

202-411-400-205_Ansicht.tcd

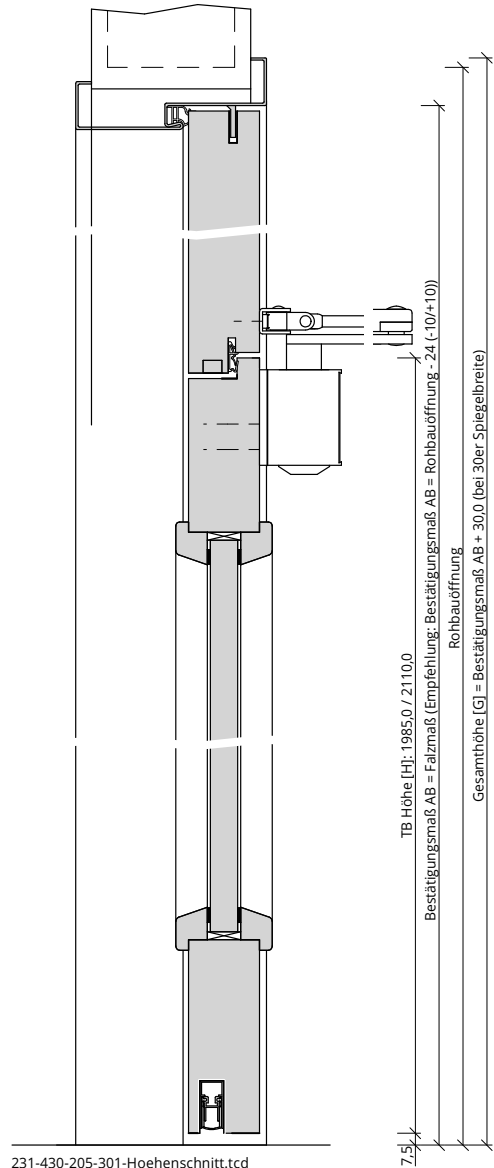

231-430-205-301-Hoehenschnitt.tcd

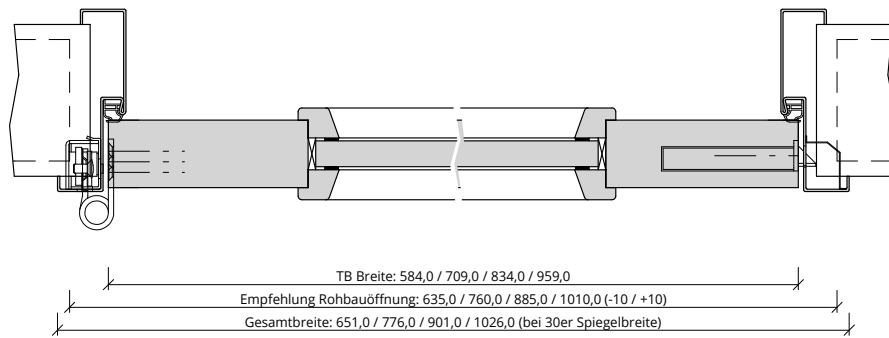

261-223-431-100-Querschnitt.tcd

