

202-411-103-302_Ansicht.tcd

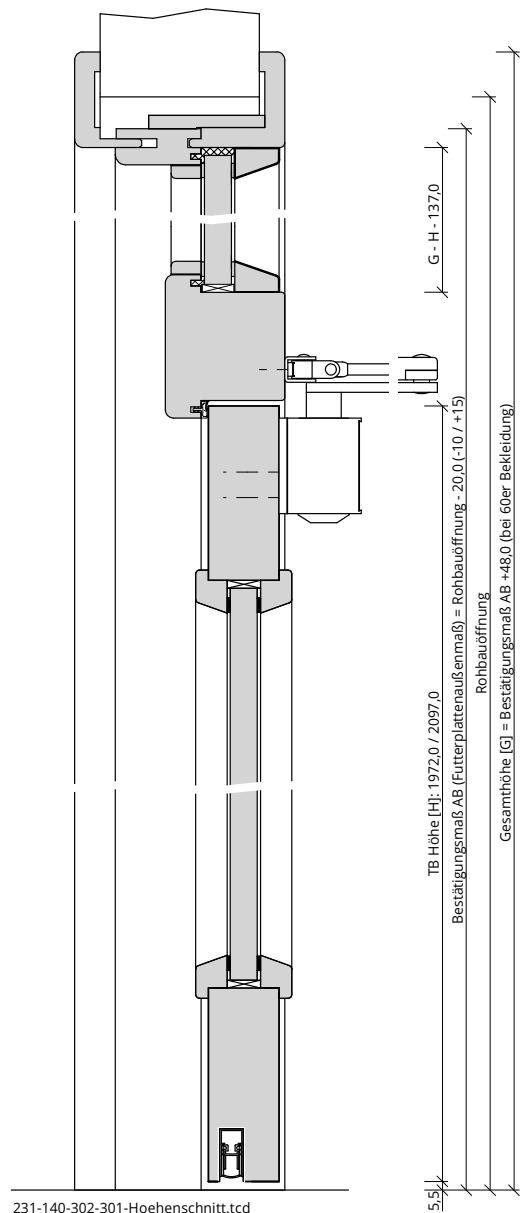

231-140-302-301-Hoehenschnitt.tcd

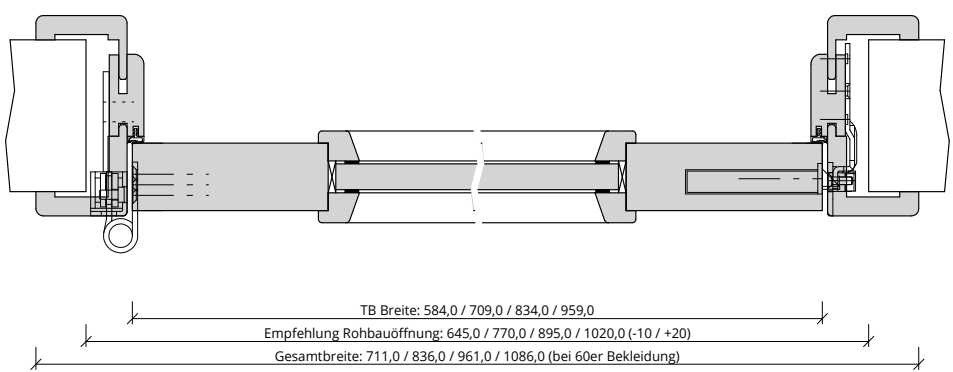

261-222-142-100-Querschnitt.tcd