

102-413-101-302_Ansicht.tcd

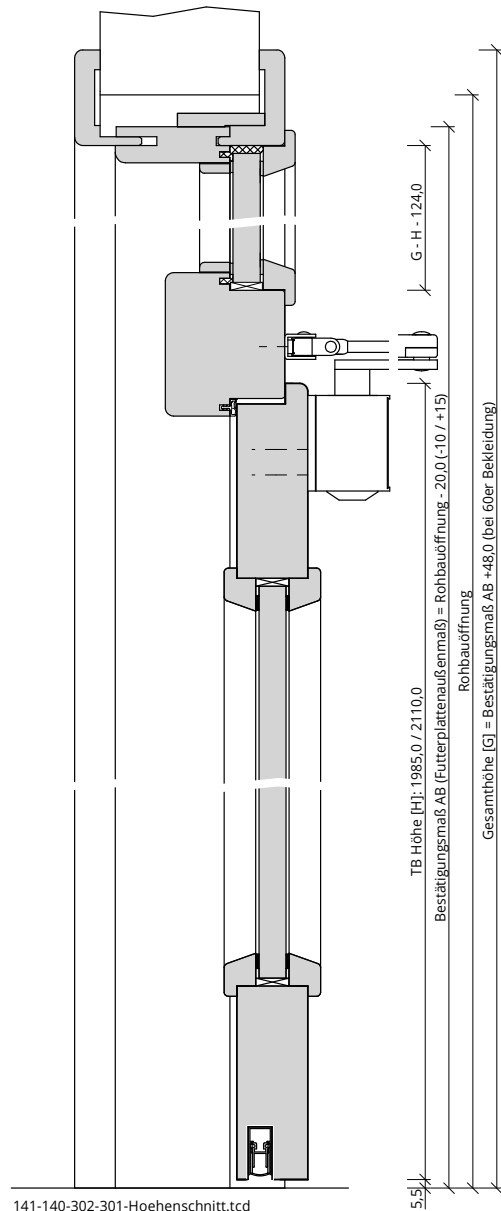

141-140-302-301-Hoehenschnitt.tcd

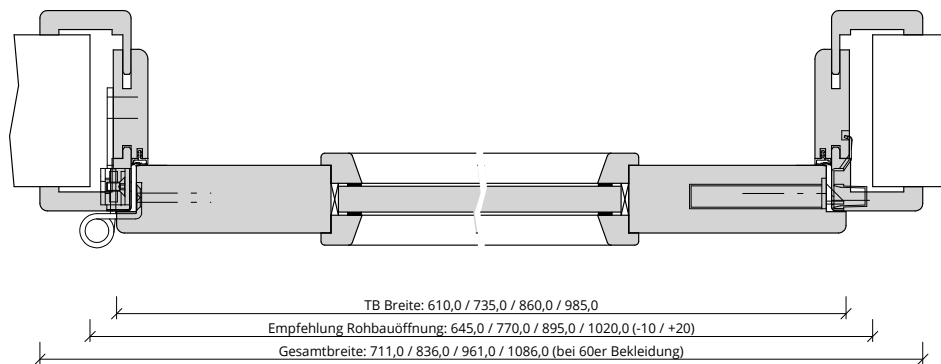

161-201-140-100-Querschnitt.tcd

