

202-411-400-302_Ansicht.tcd

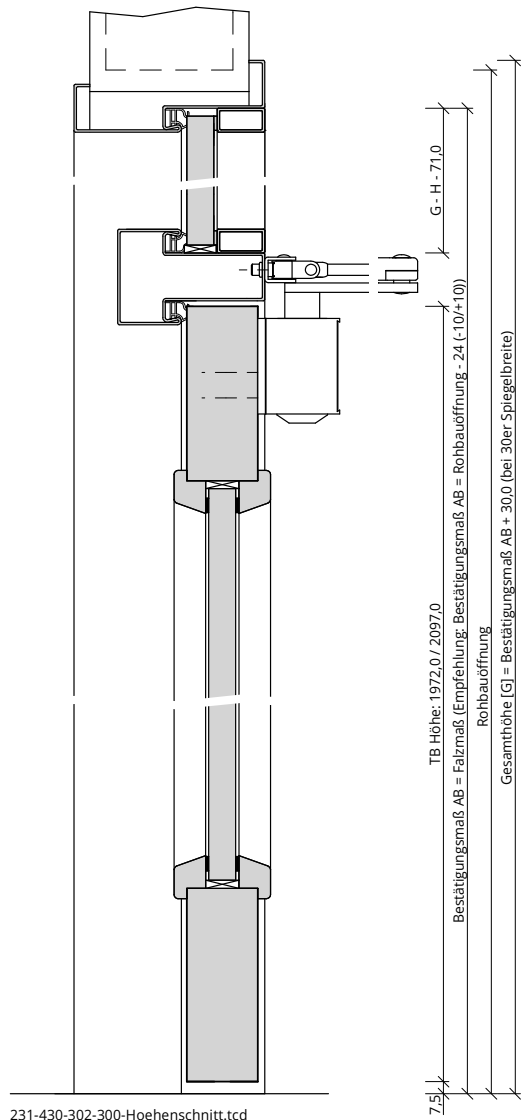

231-430-302-300-Hoehenschnitt.tcd

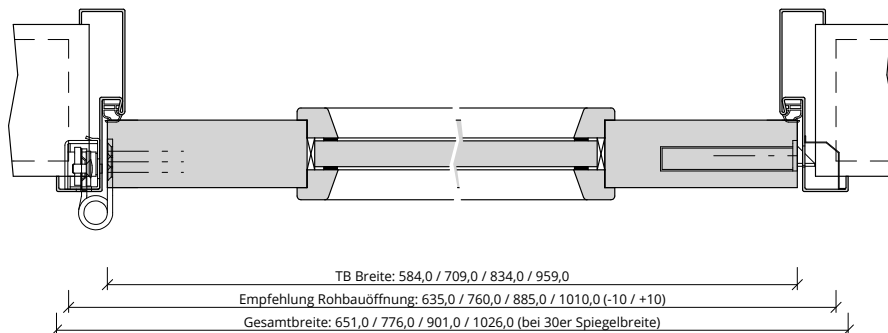

261-223-431-100-Querschnitt.tcd

