

Türenhandbuch » Funktionstüren » Schallschutz » Türblatt + Holzarge (2-flg.)
 » mit Oberblende (Typ 33) » gefälzt » SSK2 (Rw=37dB) VS3/40-LA BA S

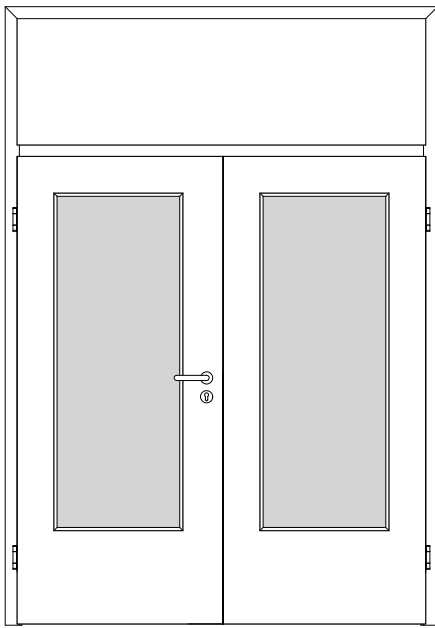

A_SD_TB-FU-2FLG_OBMKMQ_GEF_SD-32-2-LA.PDF

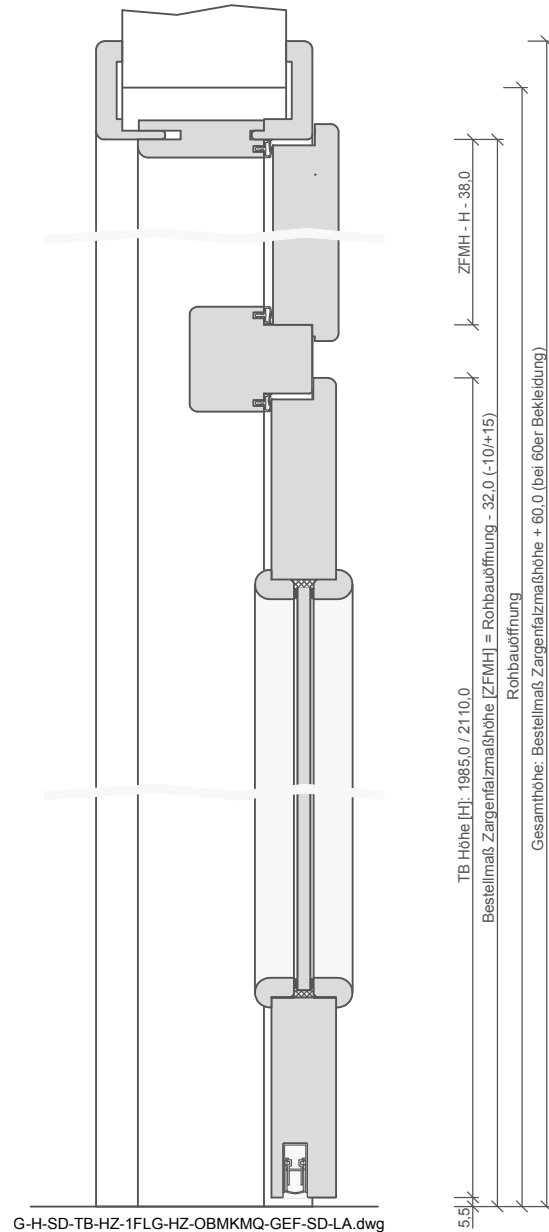

G-H-SD-TB-HZ-1FLG-HZ-OBKMQ-GEF-SD-LA.dwg

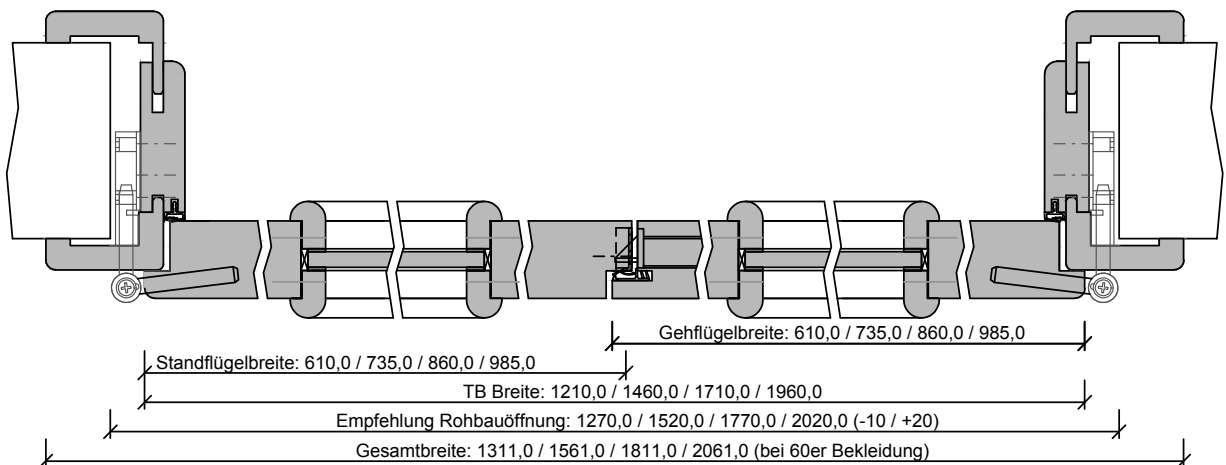

G-Q-SD-TB-HZ-2FLG-SH-GEF-SD-LA.dwg

