

A_SD_TB-BLO-1FLG_WF3_STU_SD-32-LA.PDF

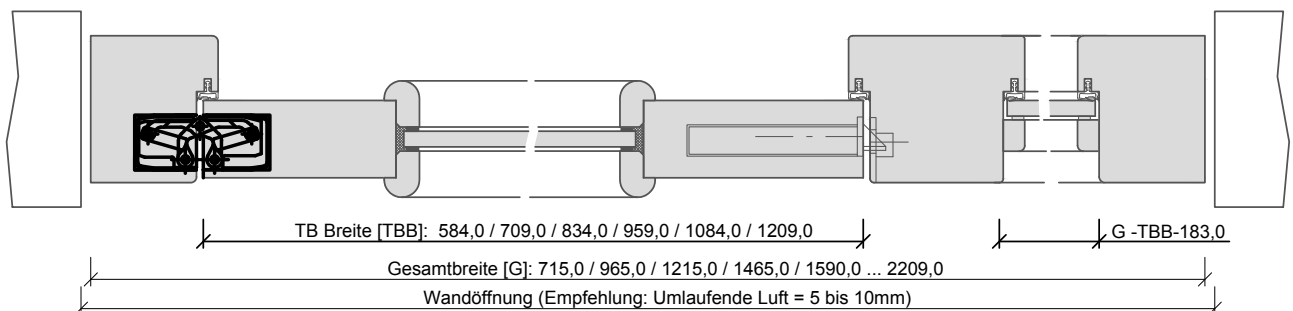

Q_RD_TB-BLO-1FLG_WF1_STU_RD-40-LA.dwg

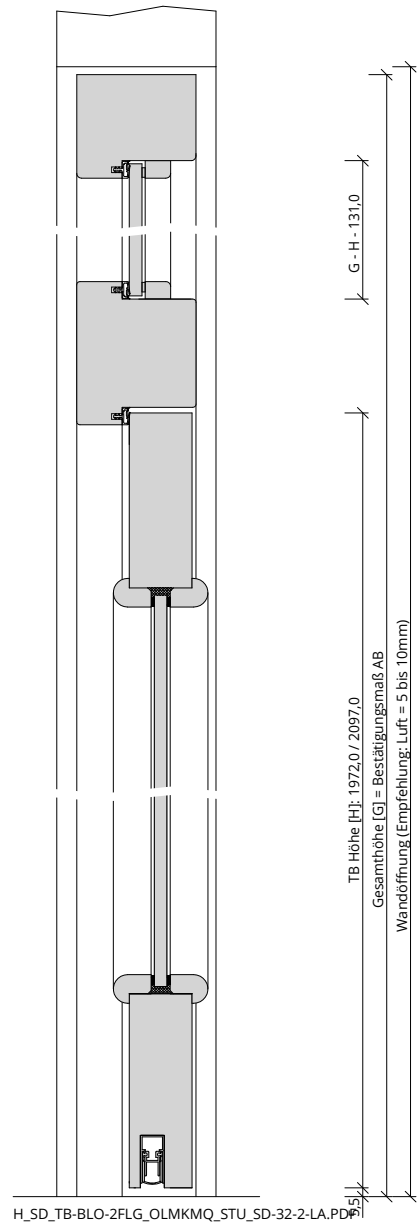